

SECTION A-A
SCALE 1 / 12

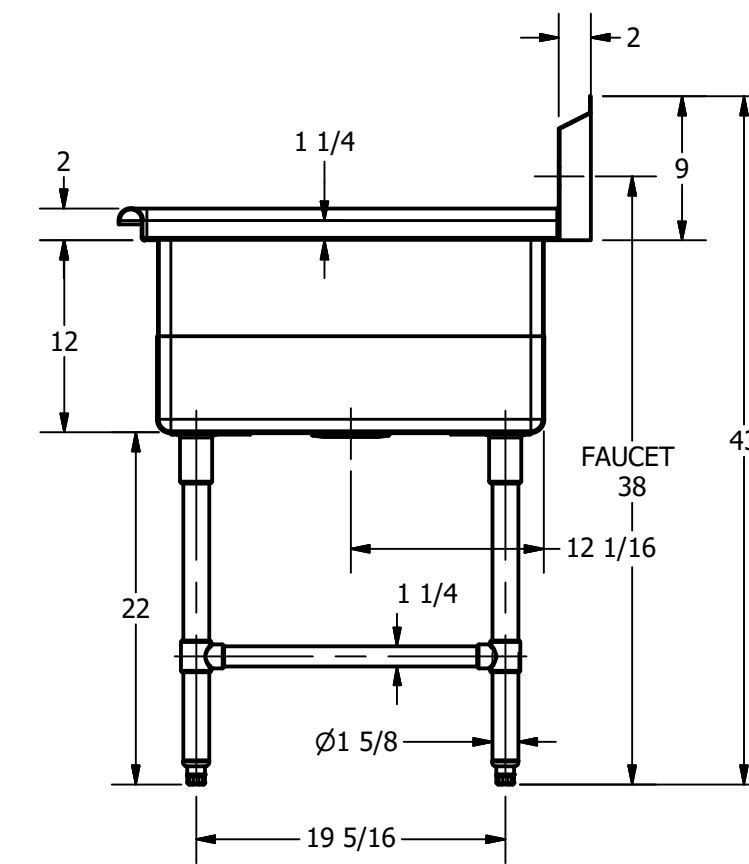

SECTION B-B
SCALE 1 / 12

REV	DESCRIPTION	DATE	APPROVED
A		12/05/17	
REVISION HISTORY			

griffin
PRODUCTS INC.
303 Blue Bird Parkway
Wills Point, Texas 75169
(800) 379-9709 / Fax: (903) 873-6389
www.gpsink.com

PART NUMBER	244.00	TITLE	PECOS SERIES SCULLERY SINK
PRODUCT CATEGORY	SCULLERY SINK	DESCRIPTION	16 GA 2 COMPARTMENT SINK WITHOUT L&R DRAINBOARD
THE INFORMATION CONTAINED IN THIS DRAWING IS THE SOLE PROPERTY OF GRIFFIN PRODUCTS, INC. ANY REPRODUCTION IN PART OR AS A WHOLE WITHOUT THE WRITTEN PERMISSION FROM GRIFFIN PRODUCTS, INC. IS PROHIBITED.		MATERIAL	16 GA (0.060 in) 304 STAINLESS STEEL
DRW. BY / DATE	DNZ 2.12.2017	APPROVED BY / DATE	
		REV.	SCALE
		1 / 12	C 1 / 1